

Kingbright®

20mm (0.8INCH) SINGLE DIGIT NUMERIC DISPLAY!

SA08-11	SC08-11	FX08-11
SA08-12	SC08-12	
SA08-13	SC08-13	
SA08-21	SC08-21	

Features

- 0.8 INCH DIGIT HEIGHT.
- LOW CURRENT OPERATION.
- EXCELLENT CHARACTER APPEARANCE.
- UNIVERSAL 1. OVERFLOW AVAILABLE.
- HIGH LIGHT OUTPUT.
- EASY MOUNTING ON P.C. BOARDS OR SOCKETS.
- I.C. COMPATIBLE.
- CATEGORIZED FOR LUMINOUS INTENSITY, YELLOW AND GREEN CATEGORIZED FOR COLOR.
- MECHANICALLY RUGGED.
- STANDARD : GRAY FACE, WHITE SEGMENT.

Description

The Bright Red source color devices are made with Gallium Phosphide Red Light Emitting Diode.

The Green source color devices are made with Gallium Phosphide Green Light Emitting Diode.

The High Efficiency Red source color devices are made with Gallium Arsenide Phosphide on Gallium Phosphide Orange Light Emitting Diode.

The Yellow source color devices are made with Gallium Arsenide Phosphide on Gallium Phosphide Yellow Light Emitting Diode.

The Super Bright Red source color devices are made with Gallium Aluminum Arsenide Red Light Emitting Diode.

Package Dimensions & Internal Circuit Diagram

SA08-11, SC08-11
SA08-12, SC08-12
SA08-13, SC08-13

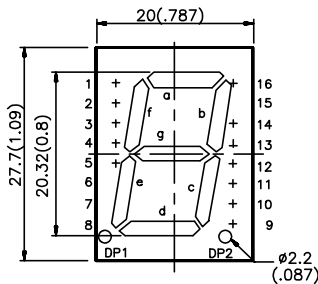

A FRONT VIEW

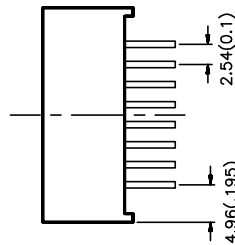

A, B SIDE VIEW

FX08-11

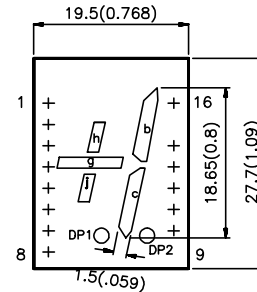

B FRONT VIEW

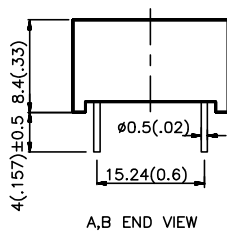

A, B END VIEW

SA08-11
SA08-12
SA08-13

COMMON ANODE
3,5,11,16

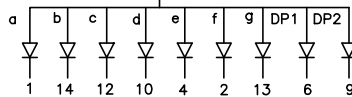

SC08-11
SC08-12
SC08-13

COMMON CATHODE
3,5,11,16

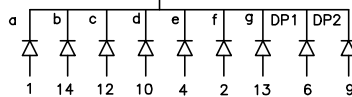

SA08-11, SC08-11 DP1 NO CHIP
SA08-12, SC08-12 DP2 NO CHIP

FX08-11

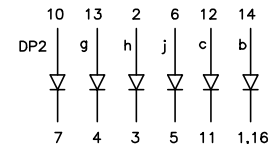

8 NO CONNECT
9, 15 NO PIN

Notes:

1. All dimensions are in millimeters (inches), Tolerance is $\pm 0.25(0.01)$ unless otherwise noted.
2. Specifications are subjected to change without notice.

Package Dimensions

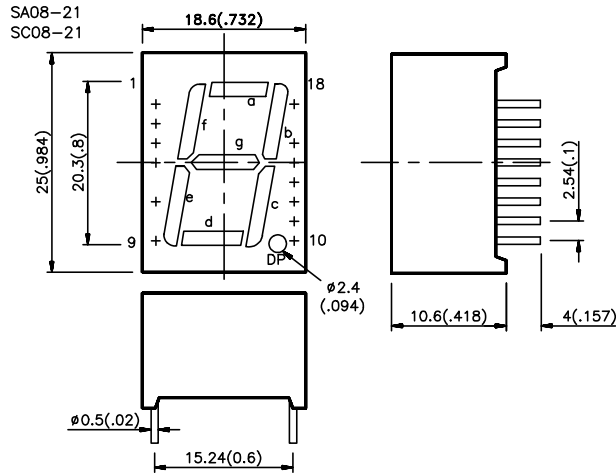

Internal Circuit Diagram

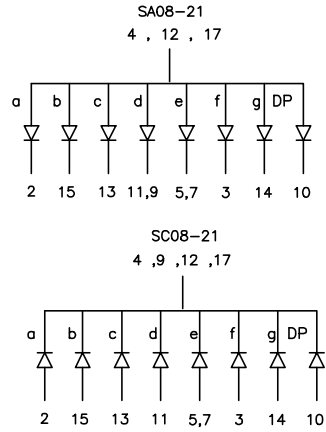

Selection Guide

Part No.	Dice	Iv (ucd) @ 10 mA		Description
		Min.	Max.	
SA08-11HWA SA08-12HWA SA08-13HWA SA08-21HWA	BRIGHT RED (GaP)	360	1400	Common Anode, Rt Hand Decimal Common Anode, Lt Hand Decimal Common Anode, Rt & Lt Hand Decimal Common Anode, Rt Hand Decimal
SC08-11HWA SC08-12HWA SC08-13HWA SC08-21HWA				Common Cathode Rt. Hand Decimal Common Cathode Lt. Hand Decimal Common Cathode Rt. & Lt Hand Decimal Common Cathode Rt. Hand Decimal
SA08-11EWA SA08-12EWA SA08-13EWA SA08-21EWA	HIGH EFFICIENCY RED (GaAsP/GaP)	2200	9000	Common Anode, Rt Hand Decimal Common Anode, Lt Hand Decimal Common Anode, Rt & Lt Hand Decimal Common Anode, Rt Hand Decimal
SC08-11EWA SC08-12EWA SC08-13EWA SC08-21EWA				Common Cathode Rt. Hand Decimal Common Cathode Lt. Hand Decimal Common Cathode Rt. & Lt Hand Decimal Common Cathode Rt. Hand Decimal
SA08-11GWA SA08-12GWA SA08-13GWA SA08-21GWA	GREEN (GaP)	3600	14000	Common Anode, Rt Hand Decimal Common Anode, Lt Hand Decimal Common Anode, Rt & Lt Hand Decimal Common Anode, Rt Hand Decimal
SC08-11GWA SC08-12GWA SC08-13GWA SC08-21GWA				Common Cathode Rt. Hand Decimal Common Cathode Lt. Hand Decimal Common Cathode Rt. & Lt Hand Decimal Common Cathode Rt. Hand Decimal
SA08-11YWA SA08-12YWA SA08-13YWA SA08-21YWA	YELLOW (GaAsP/GaP)	1400	5600	Common Anode, Rt Hand Decimal Common Anode, Lt Hand Decimal Common Anode, Rt & Lt Hand Decimal Common Anode, Rt Hand Decimal
SC08-11YWA SC08-12YWA SC08-13YWA SC08-21YWA				Common Cathode Rt. Hand Decimal Common Cathode Lt. Hand Decimal Common Cathode Rt. & Lt Hand Decimal Common Cathode Rt. Hand Decimal
SA08-11SRWA SA08-12SRWA SA08-13SRWA SA08-21SRWA	SUPER BRIGHT RED (GaAlAs)	9000	21000	Common Anode, Rt Hand Decimal Common Anode, Lt Hand Decimal Common Anode, Rt & Lt Hand Decimal Common Anode, Rt Hand Decimal
SC08-11SRWA SC08-12SRWA SC08-13SRWA SC08-21SRWA				Common Cathode Rt. Hand Decimal Common Cathode Lt. Hand Decimal Common Cathode Rt. & Lt Hand Decimal Common Cathode Rt. Hand Decimal
FX08-11HWA	BRIGHT RED (GaP)	560	2200	Universal 1. Overflow
FX08-11EWA	HIGH EFFICIENCY RED (GaAsP/GaP)	2200	9000	Universal 1. Overflow
FX08-11GWA	GREEN (GaP)	3600	14000	Universal 1. Overflow
FX08-11YWA	YELLOW (GaAsP/GaP)	1400	5600	Universal 1. Overflow
FX08-11SRWA	SUPER BRIGHT RED (GaAlAs)	5600	14000	Universal 1. Overflow

Electrical / Optical Characteristics at T_A=25°C

Symbol	Parameter	Device	Typ.	Max.	Units	Test Conditions
λ_{peak}	Peak Wavelength	Bright Red High Efficiency Red Green Yellow Super Bright Red	700 625 565 590 660		nm	IF=20mA
$\Delta\lambda_{1/2}$	Spectral Line Halfwidth	Bright Red High Efficiency Red Green Yellow Super Bright Red	45 45 30 35 20		nm	IF=20mA
C	Capacitance	Bright Red High Efficiency Red Green Yellow Super Bright Red	40 12 45 10 95		pF	VF=0V;f=1MHz
V _F	Forward Voltage	Bright Red High Efficiency Red Green Yellow Super Bright Red	2.0 2.0 2.2 2.1 1.85	2.5 2.5 2.5 2.5 2.5	V	IF=20mA
I _R	Reverse Current	All	10		uA	VR = 5V

Absolute Maximum Ratings at T_A=25°C

Parameter	Bright Red	High Efficiency Red	Green	Yellow	Super Bright Red	Units
Power dissipation	120	105	105	105	100	mW
DC Forward Current	25	30	25	30	30	mA
Peak Forward Current [1]	150	150	150	150	150	mA
Reverse Voltage	5	5	5	5	5	V
Operating/Storage Temperature	-40°C To +85 °C					
Lead Soldering Temperature [2]	260°C For 5 Seconds					

- Notes:
 1. 1/10 Duty Cycle, 0.1ms Pulse Width.
 2. 4mm below package base.

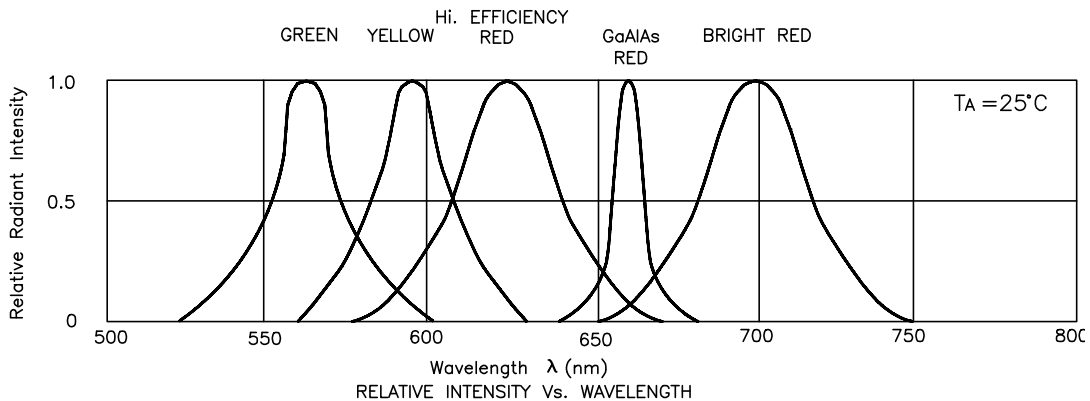

Bright Red

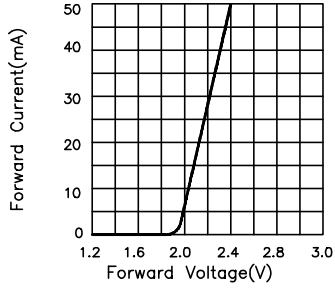

FORWARD CURRENT Vs. FORWARD VOLTAGE

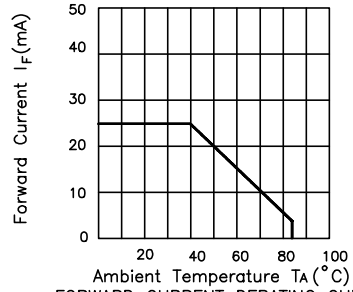

FORWARD CURRENT DERATING CURVE

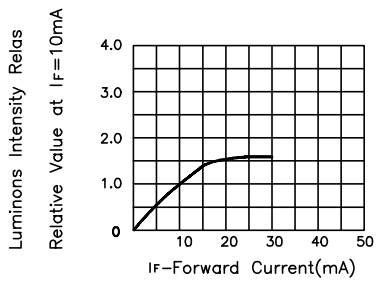

LUMINOUS INTENSITY Vs. FORWARD CURRENT

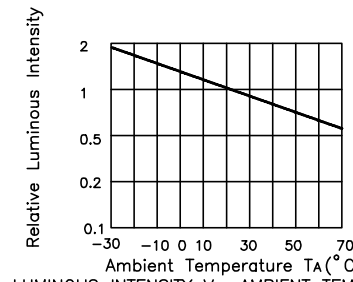

LUMINOUS INTENSITY Vs. AMBIENT TEMPERATURE

High Efficiency Red

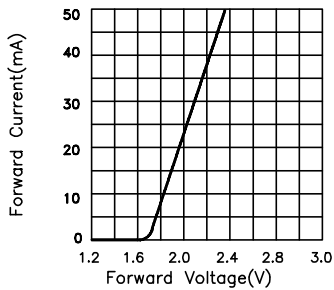

FORWARD CURRENT Vs. FORWARD VOLTAGE

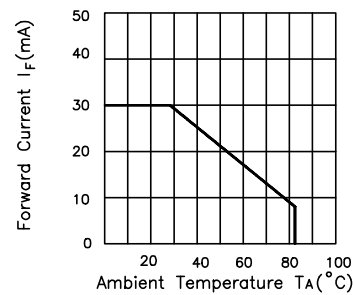

FORWARD CURRENT DERATING CURVE

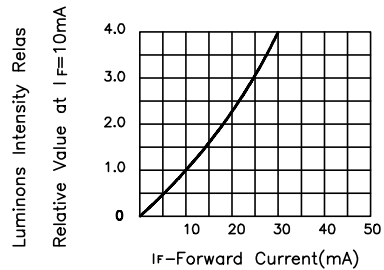

LUMINOUS INTENSITY Vs. FORWARD CURRENT

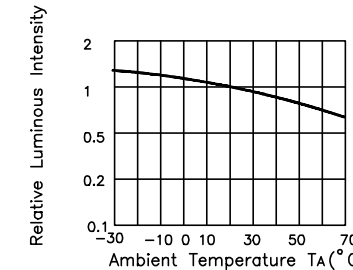

LUMINOUS INTENSITY Vs. AMBIENT TEMPERATURE

Green

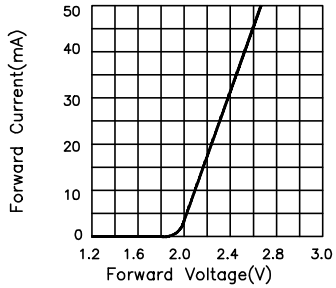

FORWARD CURRENT Vs. FORWARD VOLTAGE

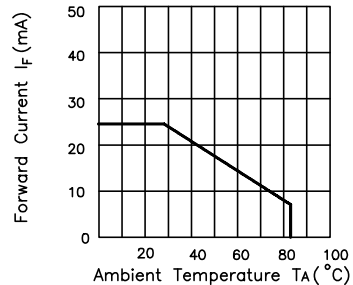

FORWARD CURRENT DERATING CURVE

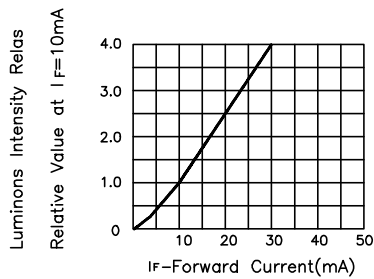

LUMINOUS INTENSITY Vs. FORWARD CURRENT

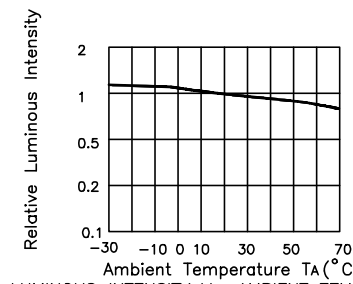

LUMINOUS INTENSITY Vs. AMBIENT TEMPERATURE

Yellow

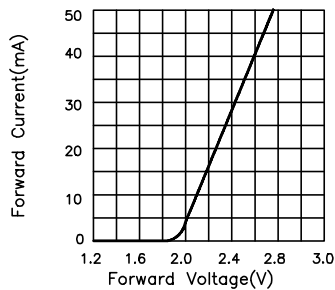

FORWARD CURRENT Vs. FORWARD VOLTAGE

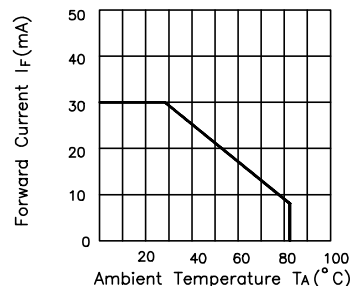

FORWARD CURRENT DERATING CURVE

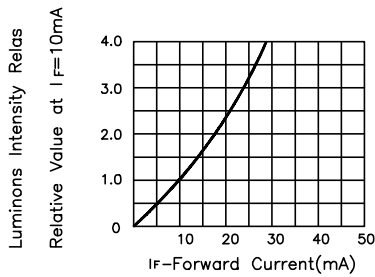

LUMINOUS INTENSITY Vs. FORWARD CURRENT

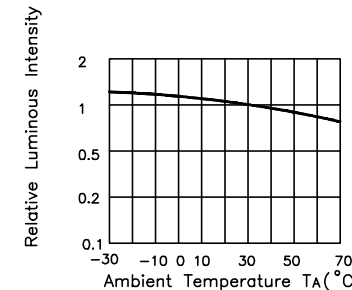

LUMINOUS INTENSITY Vs. AMBIENT TEMPERATURE

Super Bright Red

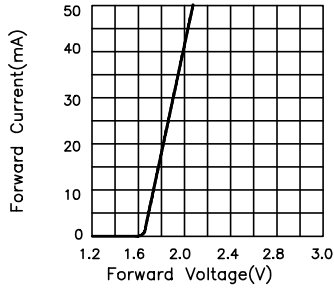

FORWARD CURRENT Vs. FORWARD VOLTAGE

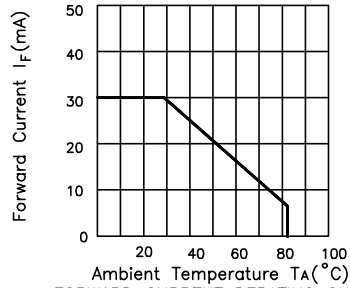

FORWARD CURRENT DERATING CURVE

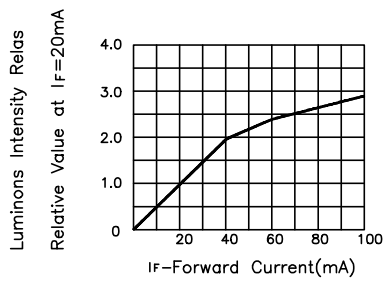

LUMINOUS INTENSITY Vs. FORWARD CURRENT

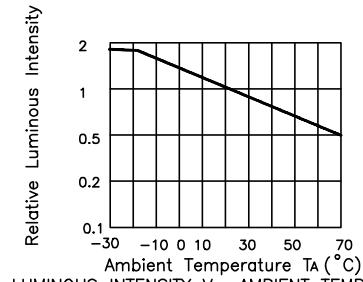

LUMINOUS INTENSITY Vs. AMBIENT TEMPERATURE